

Model #:MBM24

Model #:MBM36

Model #:MBM42

MODEL #MBM24, PERSPECTIVE VIEW

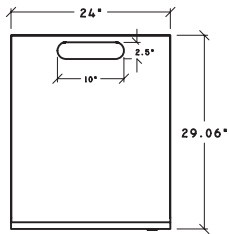

TOP VIEW

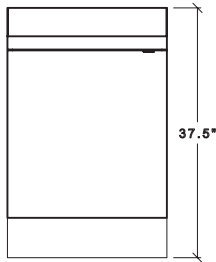

FRONT VIEW

110lbs. with top

MODEL #MBM36, PERSPECTIVE VIEW

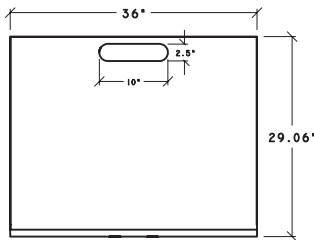
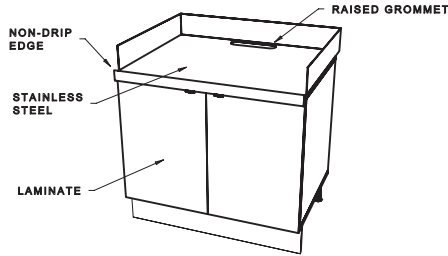

TOP VIEW

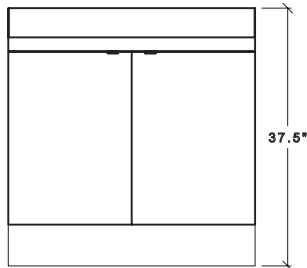

FRONT VIEW

165lbs. with top  
All weights exclude skid or crating

MODEL #MBM42, PERSPECTIVE VIEW

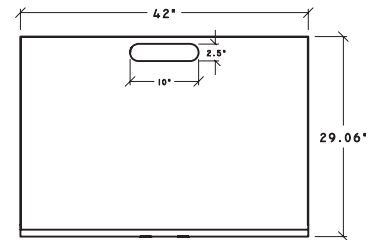
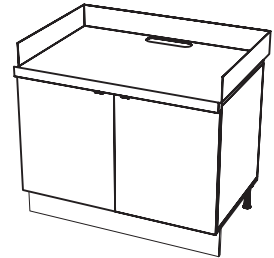

TOP VIEW

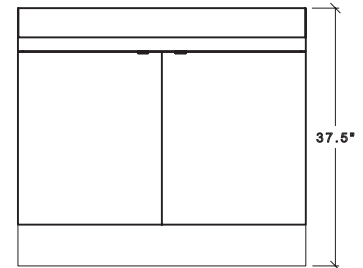

FRONT VIEW

195lbs. with top

**FEATURES**

- ◆ Use on rear service line
- ◆ Plastic laminate door
- ◆ Black melamine interior
- ◆ Includes stainless Steel 16 gauge 304 series counter top with Spill-proof™ edges, integrated covered corner backsplash and raised 2-1/2" x 10" plumbing and electrical grommet hole.
- ◆ Reversible door swing
- ◆ Raised 2-1/2" x 10" plumbing & electrical grommet hole.
- ◆ Integrated waterproof metal legs are fully adjustable
- ◆ Removable toekick is marine grade plywood with black laminate finish.

**Options:**

- ◆ Stainless steel modular base cabinet construction.

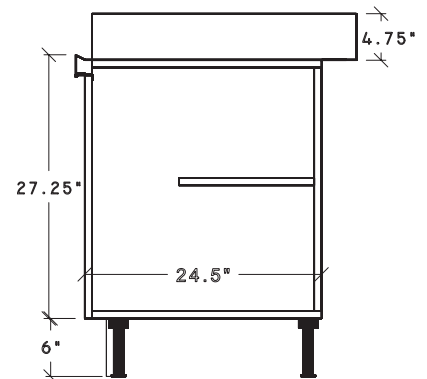

405 West Street ■ West Bridgewater, MA 02379 ■ p:800.645.7625 ■ f:617.687.7700  
e:sales@millrock.com ■ www.millrock.com

© 2000 - 2006 Modular Brand Group, LLC All Rights Reserved. Millrock is a division of Modular Brand Group, LLC  
Continual product improvement may necessitate changes in specifications without notice